

TRANSIENT PERFORMANCE ANALYSIS OF CPSS AND FUZZY LOGIC POWER SYSTEM STABILIZER BASED POWER SYSTEM

Chander Shekhar
Research Scholar
Electrical Engineering Deptt.
DCRUST Murthal, India

Anil Kumar
Assistant Prof.
Electrical Engineering Deptt
DCRUST Murthal, India

Sandeep Dhundhara
Research Scholar
Electrical Engineering Deptt
DCRUST Murthal, India

Abstract— This paper analyzed a comparative transient performance includes work on the development of a fuzzy logic power system stabilizer to enhance the damping of generator oscillations In order to accomplish a stability enhancement. Speed deviation (A_m) and acceleration (A_w) of the rotor synchronous generator were taken as the input to the fuzzy logic controller. These variables take significant effects on damping the generator shaft mechanical oscillations. The stabilizing signals were computed using the fuzzy membership function depending on these variables. The performance of the fuzzy logic power system stabilizer was compared with the conventional power system stabilizer and without power system stabilizer. To achieve good damping characteristics over a wide range of operating conditions, speed deviation and acceleration of a synchronous machine are chosen as the input Signal to the stabilizers. The stabilizing signal is determined from certain rules for rule-based power system stabilizer. For fuzzy logic based power system stabilizer, the supplementary stabilizing signal is determined according to the fuzzy membership function depending on the speed and acceleration states of the generator.

The simulations were tested under different operating conditions and change in reference voltage also tested with different membership functions. The simulation result shows that the proposed fuzzy logic based power system stabilizer is superior to Conventional Power system stabilizers (CPSSs) due to its lower computation burden and robust performance.

Index Terms— Automatic Generation Control (AGC), Automatic Voltage Regulator (AVR), Conventional Power System Stabilizer (CPSS), Fuzzy Logic Power System Stabilizer (FLPSS).

1 **Introduction** : In any power system, oscillations may arise due to line Faults, bus bar faults or load changes. so it is desirable feature to achieve better frequency constancy. However, both active and reactive power demands are never steady and they continually change with the rising or falling trend. The Steam input to turbo-generators (or water input to hydro-generator) must, therefore, be continuously regulated to match the active power demand, failing which the machine speed will vary with consequent change in frequency which may be highly Undesirable (maximum permissible change in power frequency is $\pm 0.1\%$). Also the excitation of generators must be continuously regulated to match the reactive power demand with reactive generation, otherwise the voltages at various system buses may go beyond the prescribed limits. In modern large interconnected systems, manual regulation is not feasible and therefore automatic generation and voltage regulation equipment is installed on each generator. To ensure the quality of the power supply, we need to design a load frequency management system that deals with the management loading of the generator with the

frequency. There has been continuing interest in designing strategy for load frequency controls has been proposed since 1970 [1-3]. Concordia and Kirchmayer [4] have studied the AGC of a hydro-thermal system considering non-reheat type thermal system neglecting generation rate constraints. Kothari, Kaul, Nanda [5] have investigated the AGC problem of a hydro-thermal system provided with integral type supplementary controllers. The model uses continuous mode strategy, where both system and controllers are assumed to work in the continuous mode. It is to be appreciated that in a realistic situation, the system works in the continuous mode whereas the controllers work in the discrete mode. Perhaps Nanda, Kothari and Satsangi [6] are the first to present comprehensive analysis of AGC of an interconnected hydrothermal system in continuous-discrete mode with classical controllers. In the interconnected hydro-thermal system used by them, the thermal system uses reheat turbine. and the hydro system uses a mechanical governor. In modern hydro thermal system, reheat type turbine and electric governor [6] are used. Generator excitation controls have been installed and made

faster to improve stability. Power system stabilizers have been added to the excitation systems to improve oscillatory instability it is used to provide a supplementary signal to the excitation system. The basic function of the power system stabilizer is to extend the stability limit by modulating generator excitation to provide positive damping torque to power swing modes. A. Chatterjee, S.P. Ghosal, and V. Mukherjee have described a comparative transient performance of single-input conventional power system stabilizer (CPSS) and dual-input power system stabilizer (PSS), namely PSS4B. Radman and Smaili have proposed the PID based power system stabilizer and Wu and Hsu [18] have proposed the self-tuning PID power system stabilizer for a multi machine power system.

A typical power system stabilizer consists of a phase compensation stage, a signal washout stage and a gain block. To provide damping, a PSS must provide a component of electrical torque on the rotor in phase with the speed deviations. Power system stabilizer input signals includes generator speed, frequency and power. For any input signal, the transfer function of the PSS must compensate for the gain and phase characteristics of the excitation system, the generator and the power system. These collectively determine the transfer function from the stabilizer output to the component of electrical torque which can be modulated via excitation control.

The PSS, while damping the rotor oscillations, can cause instability of the turbine generator shaft torsional modes.

Selection of shaft speed pick-up location and torsional notch filters are used to attenuate the torsional mode frequency signals. The PSS gain and torsional filter however, adversely affects the exciter mode damping ratio. The use of accelerating power as input signal for the PSS attenuates the shaft torsional modes inherently, and mitigates the requirements of the filtering in the main stabilizing path

I. SYSTEM UNDER INVESTIGATION

A single machine connected to infinite bus system (SMIB) is considered [2]. The MATLAB-SIMULINK representation of SMIB system with AVR, exciter, Synchronous generator, CPSS loop and FLPSS loop is shown in figure 1. The synchronous generator with AVR, IEEE STIA thyristor excitation system along with generator and equivalent transmission line reactance are represented by a two axis fourth order model. The objectives of the work are (1) To study the nature of power system stability, excitation system, automatic voltage regulator for synchronous machine and power system stabilizer. (2) To develop a fuzzy logic based power system stabilizer which will make the system quickly stable when fault occurred in the transmission line. (3) By using simulation to validate fuzzy logic based power system stabilizer and its performance is compared with conventional power system stabilizer and without power system stabilizer.

II. SINGLE INPUT CONVENTIONAL POWER SYSTEM STABILIZER

The basic function of a PSS is to add damping to the generator rotor oscillations by controlling its excitation using auxiliary stabilizing signal. To provide damping, the stabilizer must produce a component of electrical torque in phase with the rotor speed deviation. For the simplicity a conventional PSS is modeled by two stage (identical), lead/lag network which is represented by a gain K_{pss} and four time constants T_{d1} to T_{d4} . This network is connected with a washout circuit of a time constant T_{ww} as shown in Figure 1.

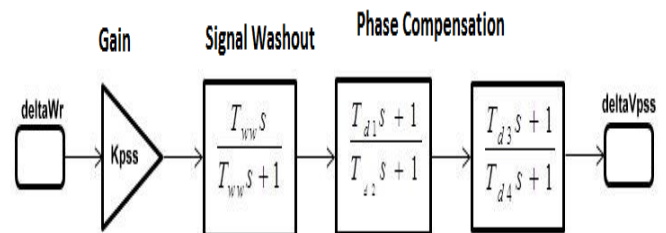

Figure 1. Block Diagram of PSS

In Figure 1 the phase compensation block provides the appropriate phase lead characteristics to compensate for the phase lag between exciter input and generator electrical torque. The phase compensation may be a single first order block as shown in Figure 1 or having two or more first order blocks or second order blocks with complex roots. The signal washout block serves as high pass filter, with time constant T_w high enough to allow signals associated with oscillations in W_r to pass unchanged, which removes d.c. signals. Without it, steady changes in speed would modify the terminal voltage. It allows PSS to respond only to changes in speed.

The stabilizer gain K_{pss} determines the amount of damping introduced by PSS. Ideally, the gain should be set at a value corresponding to maximum damping; however, it is limited by other consideration.

$$\Delta E_d = \left[\frac{K_f}{(1 + ST_{dc})} \right] \Delta f \quad (1)$$

Where ΔE_d is the incremental change in converter voltage; T_{dc} is the converter time delay, K_f is the gain of the control loop and S is the Laplace operator d/dt

III. FUZZY-LOGIC BASED POWER SYSTEM STABILIZER

Power system stabilizers (PSSs) are added to excitation system to enhance the damping during low frequency oscillations.

tions. This paper presents a study of fuzzy logic based PI controller with power system stabilizer (PSS) for stability enhancement of a single machine power system. In order to accomplish the stability enhancement, speed deviation ($\Delta\omega$) and acceleration ($\Delta\delta$) of the rotor of synchronous generator were taken as the input to the fuzzy logic controller. These variables take significant effects on damping of the generator shaft mechanical oscillations. The stabilizing signals were computed using the fuzzy membership functions depending on these variables.

The performance of the fuzzy based PI controller is compared with the conventional power system stabilizer (CPSS) and PI controller. The simulations were tested under different operating condition. In the design of fuzzy-logic controllers, unlike most conventional methods, a mathematical model is not required to describe the system under study. It is based on the implementation of fuzzy logic technique to PSS to improve system damping. The effectiveness of the fuzzy logic PSS in a single machine infinite bus is demonstrated by the Simulink program (MATLAB Software). The nonlinear model of single machine infinite bus system (SMIB) developed using Simulink. The performance of fuzzy logic PSS is compared with and without CPSS. The stabilizing signal is introduced in the excitation system. After choosing proper variables as input and output of fuzzy controller, it is required to decide on the linguistic variables. These variables transform the numerical values of the input of the fuzzy controller to fuzzy quantities. The number of these linguistic variables specifies the quality of the control which can be achieved using the fuzzy controller. As the number of the linguistic variables increases, the Computational time and required memory increase

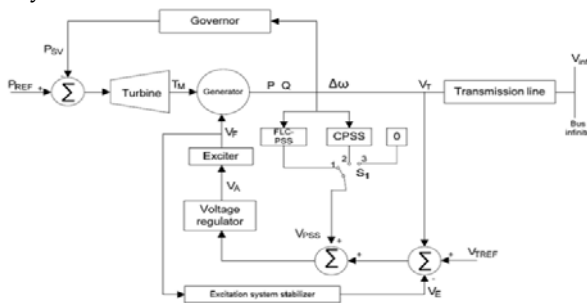

Figure 2: Test System for Proposed Fuzzy Logic Based PSS

Therefore, a compromise between the qualities of control and computational time is needed to choose the number of linguistic variables. Decision in table 1 shows the result of 49 rules, where a positive control signal is for the deceleration control and a negative signal is for acceleration control.

Table 1: Knowledge Base

	LN	MN	SN	VS	SP	MP	LP
LP	VS	SP	MP	LP	LP	LP	LP
MP	SN	VS	SP	MP	MP	LP	LP
SP	MN	SN	VS	SP	SP	MP	LP
VS	MN	MN	SN	VS	SP	MP	MP
SN	LN	LN	SN	SN	VS	SP	MP
MN	LN	LN	MN	MN	SN	VS	SP
LN	LN	LN	LN	LN	MN	SN	VS

IV. SIMULATION RESULTS

The performance of the proposed model is tested on Single Machine Infinite Bus System (SMIB) as shown in Figure 2. Then the performance of SMIB system has been studied without excitation system, with excitation system, with conventional PSS (lead-lag) and with fuzzy logic based PSS by using the K constants. The dynamic models of synchronous machine, excitation system, prime mover, governing system and conventional PSS are consider with Heffron-Phillip's(Kconstant) model.

The performance of the stabilizers designed by using modified K-constants is evaluated on a SMIB test system over a range of operating conditions as shown in table 2. The system data is

Given in the Appendix. Conventional PSS is designed following the tuning guidelines [2] for $X_e = 0.4$ p.u.

The PSS data for both the conventional design and the proposed method are also given in the Appendix. The transformer reactance X_t is 0.1p.u. The total impedance between the generator bus and the infinite bus, denoted by X_e varies with system conditions.

Table 2: showing Range of operating Conditions for SMIB

X_e (p.u)	Active Power (P_t) in p.u	Reactive Power (Q_t) in p.u	Power Factor
$X_e = 0.5$ - Nominal	1	0.2	Lagging
$X_e = 0.3$ - Strong	0.8	0.23	Lagging
$X_e = 0.9$ - Weak	1	0.5	Lagging

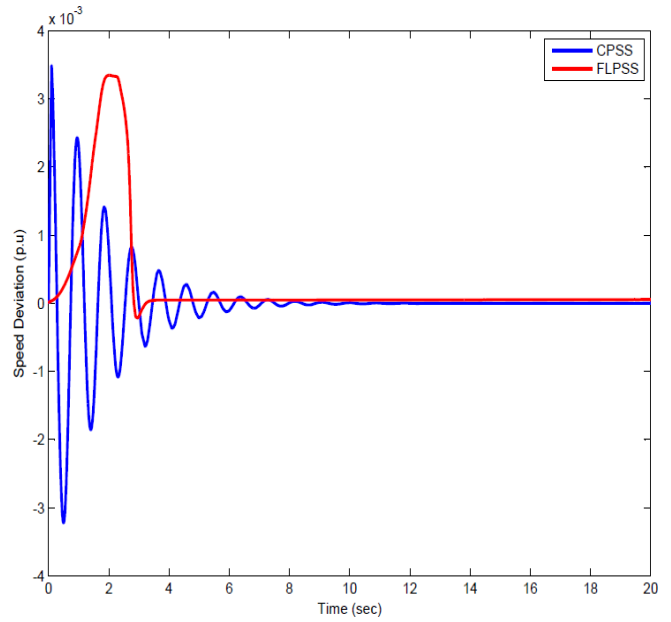
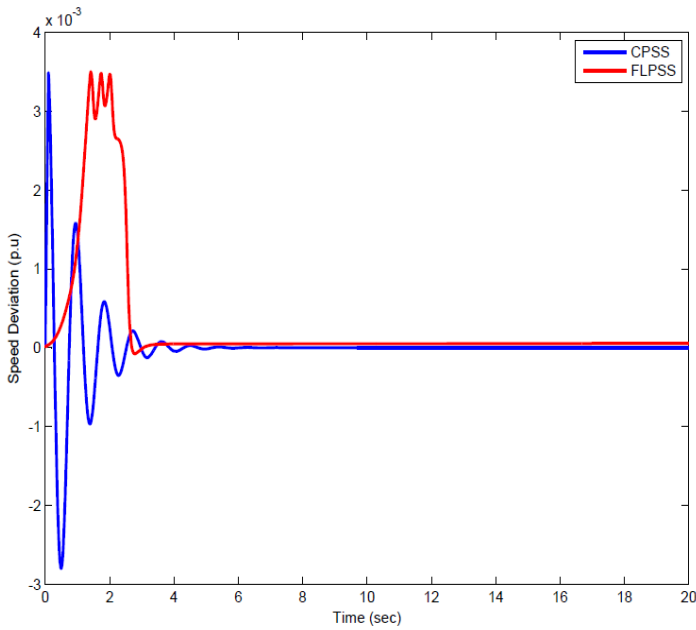

Figure 3 : Comparison of angular speed between CPSS and FLPSS for +ve $K5$

Figure 4: Comparison of angular speed between CPSS and FLPSS for -ve $K5$

under Nominal condition

under Nominal condition

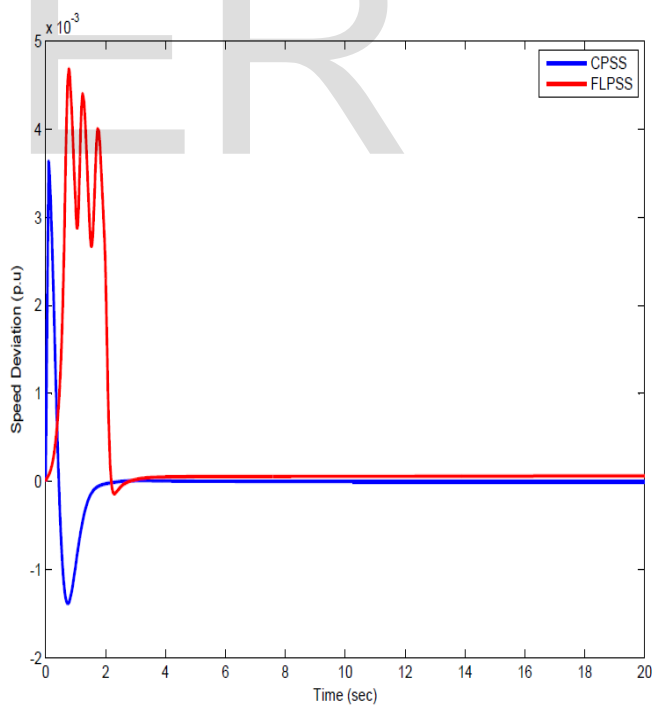
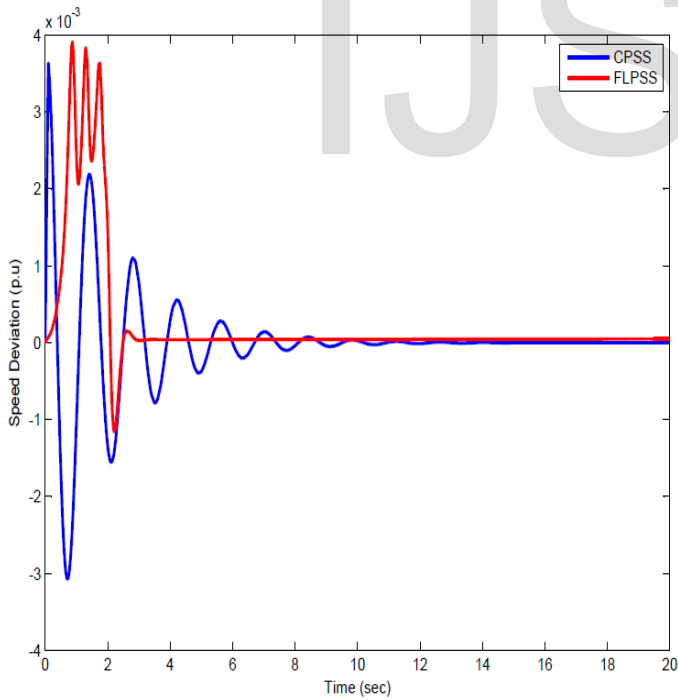

Figure 5 : Comparison of angular speed between CPSS and FLPSS for -ve $K5$

Figure 6: Comparison of angular speed between CPSS and FLPSS for +ve $K5$

under weak condition

under weak condition

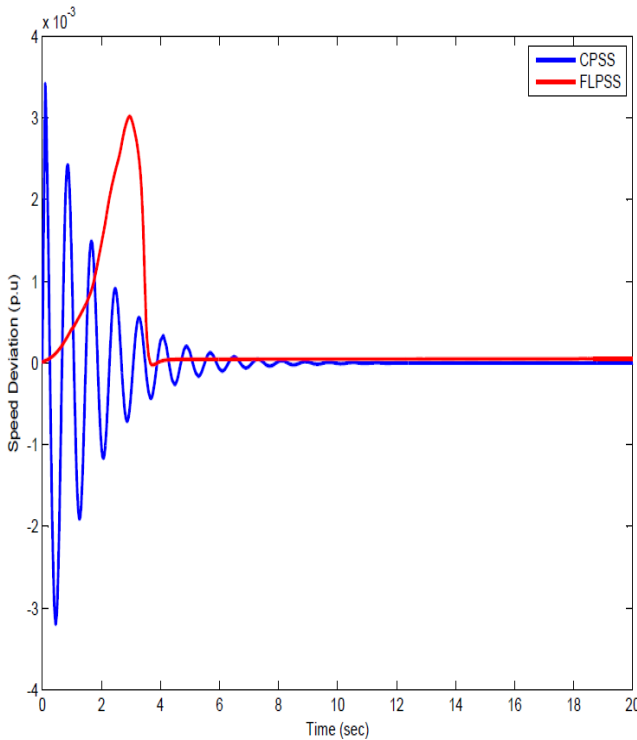

Figure 7: Comparison of angular speed between CPSS and FLPSS for +ve K5 under Strong condition

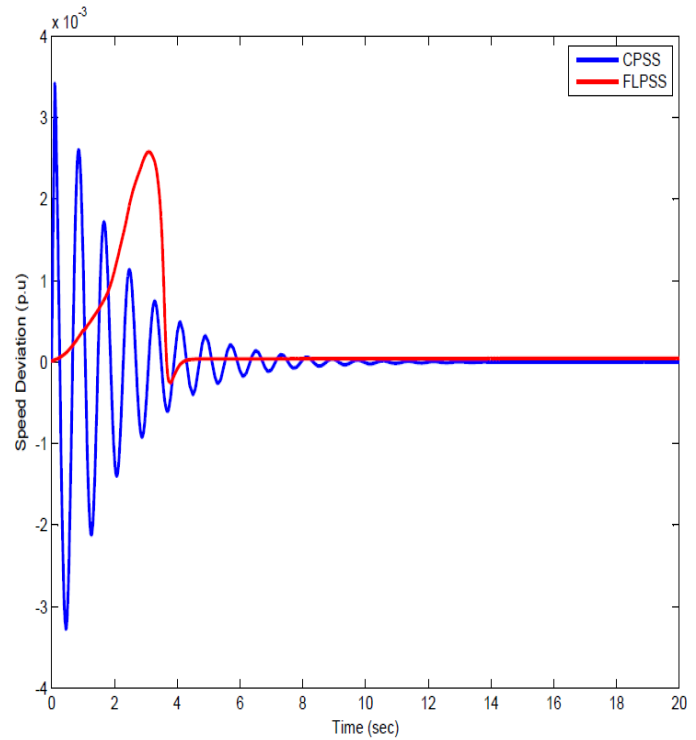

Figure 8: Comparison of angular speed between CPSS and FLPSS for -ve K5 under Strong condition

Figure 3 to Figure 7 shows the Comparison of angular speed between CPSS and FLPSS for +ve K5 and -ve K5 under Nominal, weak and Strong condition.

From Figure 3 to Figure 8 it shows that oscillations in angular speed reduces much faster with fuzzy logic based PSS (FLPSS) than with conventional PSS (CPSS) for both cases i.e. for positive and negative value of K5 constant.

As shown in Figure 7 with fuzzy logic based PSS (FLPSS), the variation in angular speed reduces to zero in about 2 to 3 seconds but with conventional PSS (CPSS), it takes about 6 seconds to reach to the final steady state value and also the oscillations are less pronounced in FLPSS.

V. CONCLUSION

In this paper initially the effectiveness of power system stabilizer in damping power system stabilizer was reviewed then fuzzy logic power system stabilizer was introduced. Speed deviation $\Delta\omega$ and acceleration Δa of synchronous generator were taken as the input signals to the fuzzy controllers. The performance of the power system with fuzzy logic power system stabilizer is better one since it is effective for all test conditions. It was also shown in the simulation results that the fuzzy logic power system stabilizer can decrease both maximum overshoot and settling time the slip. The control

Appendix:

Machine Data:

$X_d = 1.6$; $X_q = 1.55$; $X_d' = 0.32$; $T_{d0} = 6$; $H = 5$; $D = 0$; $f = 50$ Hz; $EB = 1p.u.$ $X_t = 0.1$; Model 1.0 is considered for the synchronous machine.

Exciter data:

$K_e = 200$; $T_e = 0.05s$; $E_{fdmax} = 6p.u.$; $E_{fdmin} = -6p.u.$;

CPSS data:

$T_1 = 0.078$; $T_2 = 0.026$; $K_{pss} = 16$; $T_w = 2$;

PSS output limits ± 0.05

REFERENCES

- [1] ANSI/IEEE std 122-1985, "IEEE recommended practice for functional and performance characteristics of control system for steam turbine generator units", *The institute of EEE USA*, 1985.
- [2] Kundur P., "Power System Stability and Control", McGraw-Hill Inc, 1994.
- [3] Anders P.M. and Faurd A.A., "Power System Control & Stability", *IEEE, Press*, Revised printing, 1994C.
- [4] Concordia and L.K.Kirchmayer, "Tie-Line Power and Frequency Control of Electric Power System - Part I", *AIEE Transaction*, vol. 73, Part- 111-A, April 1954, pp. 133-146.
- [5] Kothar M.L i, .Kaul B.L and Nanda J., "Automatic Generation Control of Hydro-Thermal system", *journal of Institute of Engineers(India)*, vol.1.6 I.
- [6] Nanda J., Kothari M.L., Satsangi P.S., "Automatic Generation Control of an Interconnected hydrothermal system in Continuous and Discrete modes considering Generation Rate Constraints",

signal, required, in all cases is with less magnitude. The proposed FPSS provides good damping characteristics during small signal oscillations. In the end it can be concluded that the performance of the proposed FPSS is much better and the oscillations are damped out much quicker.

- IEE Proc.*, vol. 130, pt D, No. I, Jan. 1983, pp 455-460.
- [7] Boenig H. J and. Hauer J. F, "Commissioning tests of the Bonneville power administration 30 MJ superconducting magnetic energy storage unit," *IEEE Trans. Power App. Syst.*, vol. PAS-104, no. 2, pp. 302-309, Feb. 1985.
- [8] Tripathy S.C., Balasubramaniam R., . Nair Chandramohan P.S, "Effect of Superconducting Magnetic Energy Storage on Automatic Generation Control Considering Governor Dead band and Boiler dynamics." *IEEE tran. On power system* Vol 7, Aug 1992.
- [9] Tripathy S.C, R. Balasubramanian, Chandramohan Nair P.S., "Small rating capacitive energy storage for dynamic performance improvement of automatic generation control", IEE proceedings, Vol 138, Jan 1991.
- [10] Peterterson H.A., Mohan N. and .Boom R.W, "Super Conductive energy storage Inductor-Converter Units for power system", *IEE Trans. On Powerapparatus and systems*, Vol. PAS-94, No.4, PP 1337-1348, July/August 1975.
- [11] Loyd R.J, J.D.Rogers et al., "A feasibility utility scale superconducting Magnetic Storage Plant", *IEEE Trans. On Energy conversion*, Vol. EC-1, No.4, PP 63-64, December 1986.
- [12] O.I Elgerd, "Electric Energy System Theory: An Introduction", (Book), McGraw Hill, 1982.
- [13] Y.Mitani, K.Tsuji, Y.Murakami, "Application of Superconducting Magnetic Energy storage to improve power system dynamic performance" *IEEE trans. On power system*, Vol 3, No.4-1988.
- [14] Rogers, J.D., Boenig, H.J., Bronson, J.C., Colyer, D.B., hassenzahl, W.V., Turner, R.D., and Schermer, R.I.: '30 MJ superconducting magnetic energy storage (SMES) unit for stabilizing an electric transmission system', *IEEE Trans.*, 1979,
- [15] Mohd. Hasan Ali, Bin Wu, and Roger A. Dougal, "An Overview of SMES Applications in Power and Energy Systems", *IEEE Transactions on Sustainable Energy*, Vol. 1, No. 1, April 2010.
- [16] V. Mukherjee, S.P. Ghoshal, 'application of capacity energy storage for transient performance improvement of power system', *Electric Power Systems Research*, june 2008.
- [17] Rajesh.J, D. Das "Automatic Generation Control of an Interconnected Power System with Capacitive Energy Storage" *IJEEE*, 2010
- [18] Michael J. Basler and Richard C. Schaefer "Understanding Power System Stabilizer," *Basler Electric Company IEEE Trans.*, pp. 46-67, August 2005.
- [19] M.L. Kothari, J. Nanda, and K. Bhattacharya, "Design of Variable Structure Power System Stabilizers with Desired Eigen values in the Sliding Mode," *IEEE Proceedings*, Part C, vol. 140, No.4, July 1993.
- [20] Recommended Practice for Excitation System Models for Power System Stability Studies," *IEEE Standard 421.5-1992*, August 1992.

IJS